

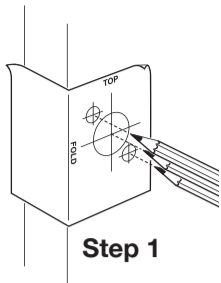

YALE LOCK PBS3 & PBS4

FITTING INSTRUCTIONS



Step 1



Step 2a



Step 2b



Step 2c

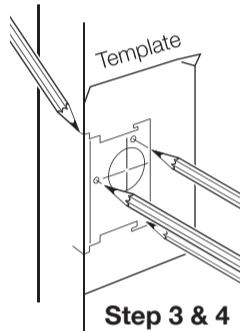

Step 3 & 4

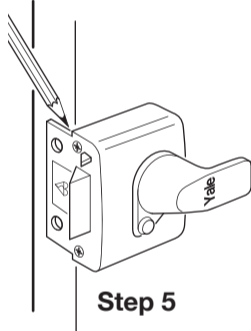

Step 5

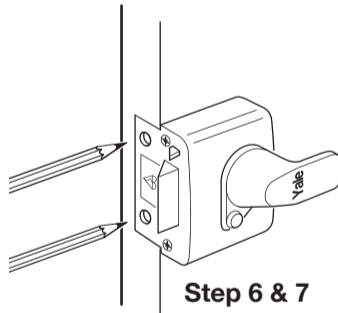

Step 6 & 7

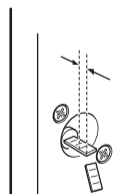

Step 8

1. Choose the correct side of the Cylinder Pull template for your door, depending on whether it is hinged on the left or right, as seen from inside.
2. At the height you want your lock, use the Cylinder Pull template provided to mark the three holes indicated on both sides of the door. At the middle mark, drilling from both sides of the door, drill a 32mm (1 1/4") diameter hole through the door.
- 2a. Working from the outside of the door, drill a 13mm (1/2") diameter hole to a depth of 16mm (5/8") at each of the two other marked spots.
(DIY TIP: Mark your drill bit with sellotape or other coloured adhesive material at the required drill depth)
- 2b. Working from the inside of the door, drill a 13mm (1/2") diameter hole to a depth of 5mm (3/16") at each of the two marked spots.
- 2c. From the inside of the door, drill 8mm (5/16") diameter holes through the centres of the two holes you drilled in Steps 2a and 2b.
3. Using your Mounting Plate template, mark the position of the three small holes, as indicated, on the inside of the door. Drill three 3mm (1/8") diameter holes to a depth of 32mm (1 1/4") at the spots you've marked.
4. Using your Mounting Plate template, mark the outline of the recess, as indicated, on the edge of the door.
5. Line up the top and bottom of the projecting kitemarked panel of the lock body with the top and bottom of the recess outline you've just drawn. Mark the outline of the panel on the door edge.
6. Using a hammer and a sharp chisel, cut out the shape of the panel to a depth of 3mm (1/8").
7. Place the lock body on the back of the door so that the projecting kitemarked panel sits in the recess you've just cut out. Mark the position of the two screw holes in the panel on the door edge. Drill two 3mm (1/8") diameter holes to a depth of 25mm (1") at the spots you've marked.
8. With the key removed, position the cylinder/door pull assembly in the door, with the flat connecting bar sticking out from the back of the door. If necessary, use a fine-toothed hacksaw to shorten the flat connecting bar so that it projects 4mm (5/32") beyond the surface of the door.
9. Screw the cylinder/door pull to the door using the large cross-headed bolts provided. You may need to shorten them with a fine-toothed hacksaw to make sure they are sunk below the door surface in the holes which you drilled for that purpose in Step 2. Tighten the bolts so that the door pull does not move.
10. Unscrew the two screws from each side of the latch bolt to release the mounting plate from the back of the lock body.
IMPORTANT: Before you remove the mounting plate, align the arrow on the rotating cross shaped slot on the back of the lock body with the arrow on the anti-drill plate. Then remove the mounting plate. Do not remove black washer.
11. Ensuring the arrows remain aligned, place the mounting plate over the connecting bar. Secure the mounting plate to the cylinder/door pull using the two 45mm (1 3/4") flat-ended connecting screws provided, screws must be inserted through the top pair of holes in the centre of the mounting plate. If necessary, use a fine-toothed hacksaw to shorten the screws to ensure they fit flush with the mounting plate. You may also need to insert the key into the cylinder and turn it to ensure adequate clearance for the screws.
12. Screw the mounting plate to the door using the woodscrews supplied at the points where you drilled holes in Step 3.
13. Remove the key. Use the handle on the lock to draw the latch bolt back into the lock body and retain it there by pressing the red latch button.
14. Engage the lock body on the hook points on the mounting plate and slide the lock body so that the projecting panel of the body fits snugly into the recess on the door edge which you cut out in Steps 5 & 6.
15. Replace the two screws on both sides of the latch bolt which hold the lock body onto the mounting plate. Secure the lock body to the door edge with two 25mm (1") woodscrews provided.
16. Gently close the door and use the fitted lock as a guide to mark the position of the remaining component the staple on the door frame.
17. Chisel out a recess in the door frame to hold the staple flush with the frame. The gap between the lock body and the staple should not exceed 5mm (3/16"). Secure the staple with the four 45mm (1 3/4") woodscrews supplied.
(DIY TIP: For ease of installation, particularly on hardwood doors, use a 3mm drill as pilot holes for the screws)

The fitting of your new lock is now complete.

OPERATION

To deadlock the door, simply pull the door closed behind you.
To hold the lock open, pull back the handle and press the red latch button. To release it, turn the handle.

CARE OF YOUR YALE LOCK

Never take your cylinder apart. Never oil or paint the cylinder. To lubricate, use WD40 or similar.
IMPORTANT: Locks with a Brasslux finish can be kept clean by an occasional wipe over with a moist, dust-free cloth. No abrasive or metal polish should be used.
LOCK: Moving parts may be greased.

FOR MAXIMUM SECURITY

The gap between the lock body and the staple should be kept to a minimum and must never exceed 5mm (3/16"), otherwise the automatic deadlock will not work.

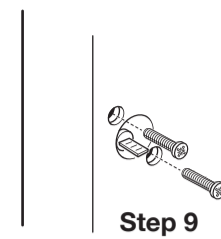

Step 9

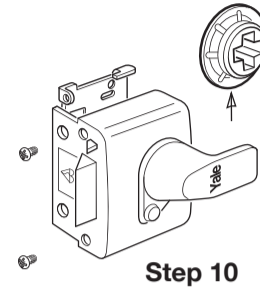

Step 10

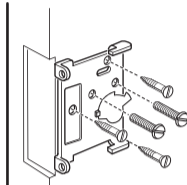

Step 11 & 12

Fitting the mounting plate

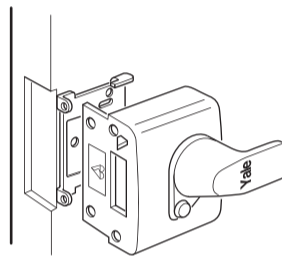

Step 13

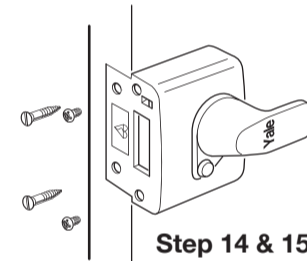

Step 14 & 15

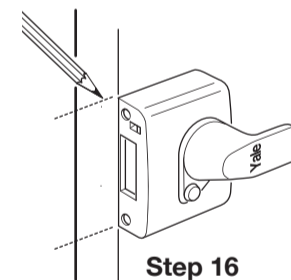

Step 16

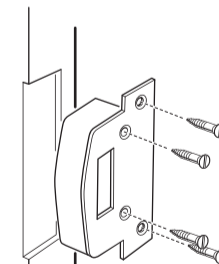

Step 17

Fitting the staple